

Sealed Nickel Cadmium Batteries

Model: PS-AAL

Specifications

| | | |
|---|-------------------------|-----------------|
| Nominal Voltage | | 1.2 Volt |
| Rated Capacity | | 600 mAh |
| Dimensions | Diameter in. (mm) | 0.56 (14.1) |
| | Height in. (mm) | 1.95 (49.5) |
| | Height with solder tabs | 1.99 (50.5) |
| Weight Approx. | Weight Approx. | 18 gm |
| | Internal Resistance | < 27 mΩ |
| | Standard Charge (0.1C) | 60 mA |
| | Trickle Charge | (0.03C)~(0.05C) |
| | Fast Charge ΔV | 600 mA |
| Recommended Operating Temperature Range | Std/Trickle Charge | 20±5°C |
| | Fast Charge | 20±5°C |
| | Discharge | 20±5°C |
| | Storage | -20°C to 45°C |
| Standard Discharge (0.2C) Cut Off Voltage | | 1.0V per cell |
| High Rate Discharge (1 C) Cut Off Voltage | | 1.0V per cell |

Dimensions

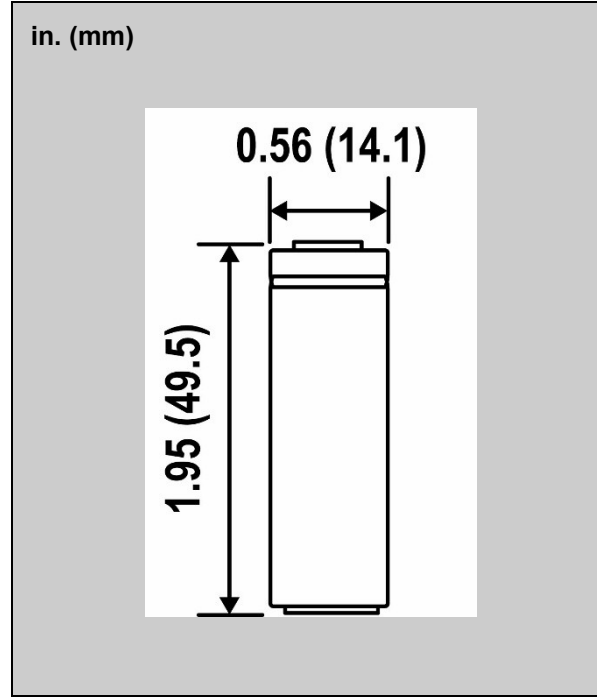

Charging and Discharging Characteristics

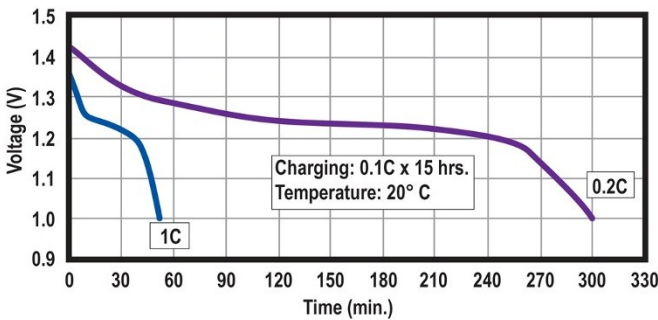

Discharge

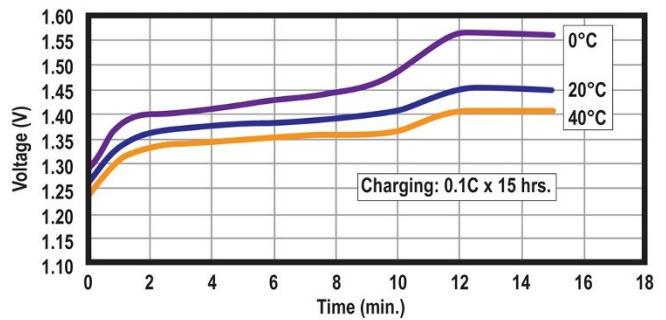

Standard Charge

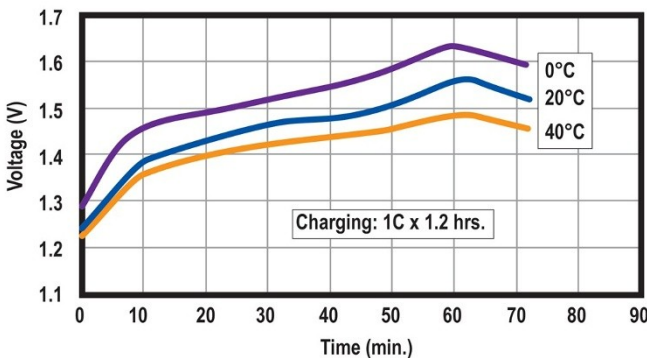

Fast Charge

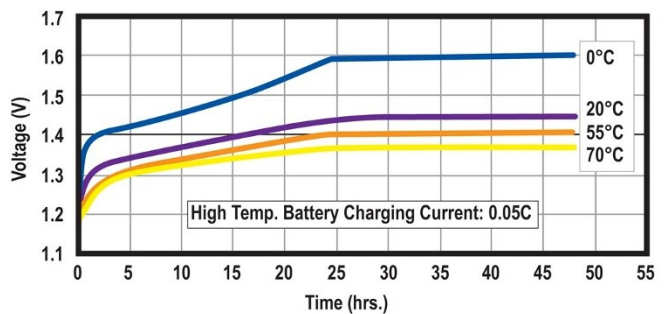

Trickle Charge



▲ Standard Battery Cycle Life ▲

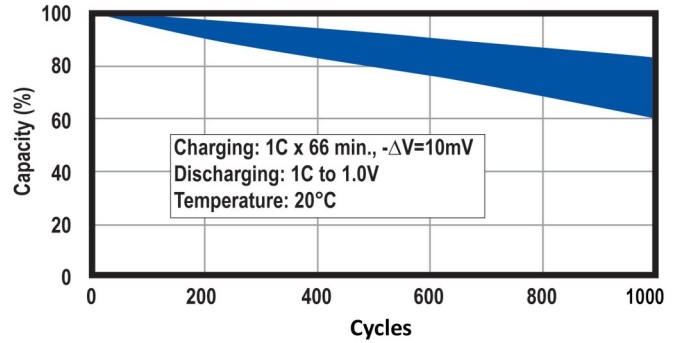

▲ Fast Charging Cycle Life ▲



▲ Cycle Life Using Trickle Charging ▲



▲ Stand-by Battery Life ▲



▲ Capacity vs. Temperature ▲

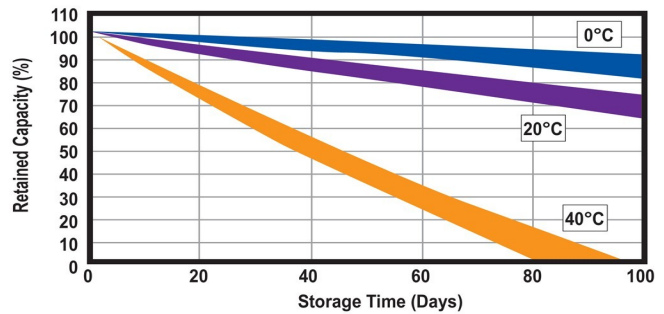

▲ Retained Capacity In Storage ▲

Corporate Headquarters and Domestic Sales

Power-Sonic Corporation • 7550 Panasonic Way • San Diego, CA 92154 • U.S.A

Phone: (619) 661-2020 • Fax: (619) 661.3650

Email Sales: national-sales@power-sonic.com

Email Customer Service: customer-service@power-sonic.com

E-mail Technical Support: technical-support@power-sonic.com

International Sales

Power-Sonic Corporation • P.O. Box 5242 • Redwood City, CA 94063 • U.S.A.

Phone: (650) 364-5001 • Fax: (650) 366-3662

Email Sales: international-sales.com@power-sonic.com

www.power-sonic.com