

Sealed Nickel-Metal Hydride Rechargeable Batteries

Model: NH-8000D

Specifications

Nominal Voltage		1.2 Volt
Rated Capacity		8000 mAh
Dimensions	Diameter in. (mm)	1.27 (32.2)
	Height in. (mm)	2.32 (59.0)
	Height with solder tabs	2.36 (60.0)
Weight Approx.	Weight Approx.	160 gm
	Internal Resistance	<9 mΩ
	Standard Charge (0.1C)	800 mA
	Trickle Charge	(0.03C)~(0.05C)
	Fast Charge ΔV	4000 mA
Recommended Operating Temperature Range	Std/Trickle Charge	20±5°C
	Fast Charge	20±5°C
	Discharge	20±5°C
	Storage	-20°C to 45°C
Standard Discharge (0.2C) Cut Off Voltage		1.0V per cell
High Rate Discharge (1 C) Cut Off Voltage		1.0V per cell

Dimensions

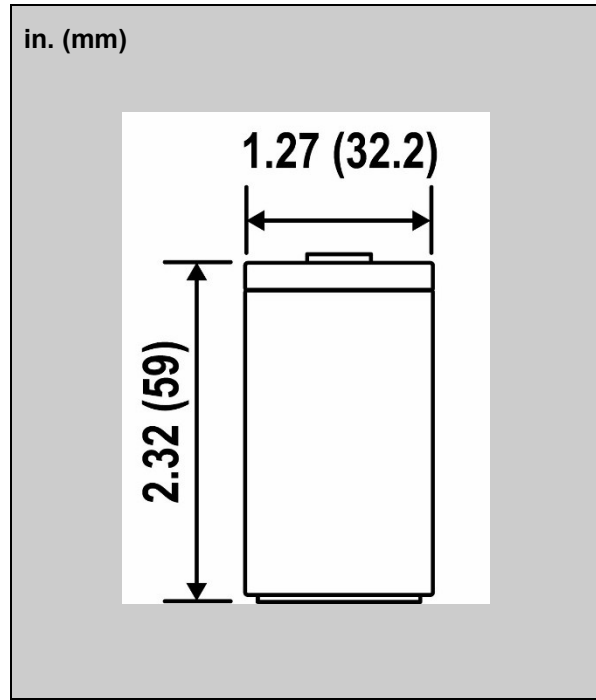

Charging and Discharging Characteristics

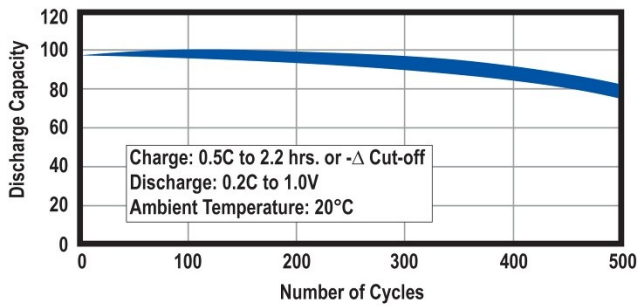

Discharge Cycle Life

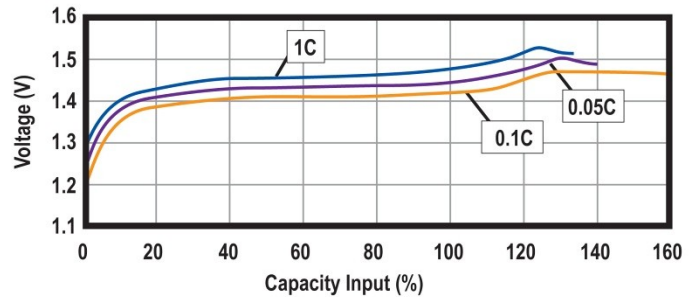

Standard Charge

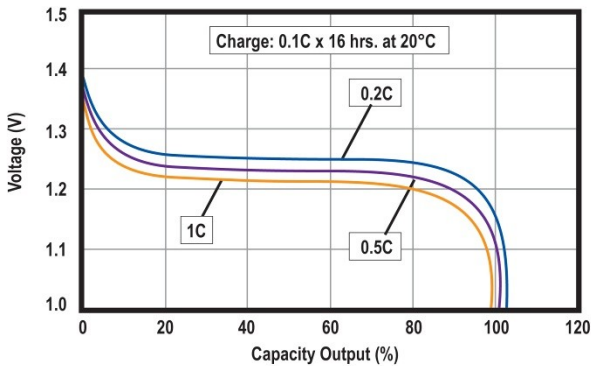

Standard Battery Discharging (0.2C/0.5C/1C)

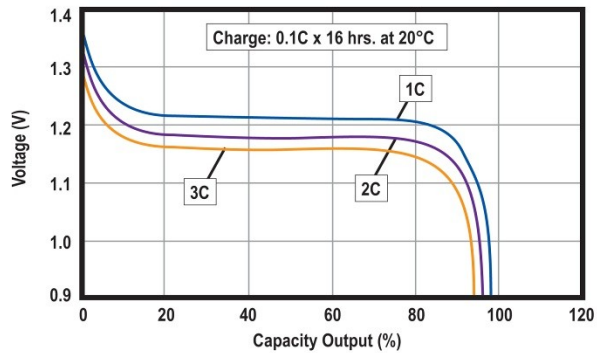

Standard Battery Discharging (1C/2C/3C)

Please note the following graphs are for High Temperature and High Power batteries. These batteries do not form part of our standard range, but both types are available on request subject to minimum order quantities and delivery times. Please contact us for further details.

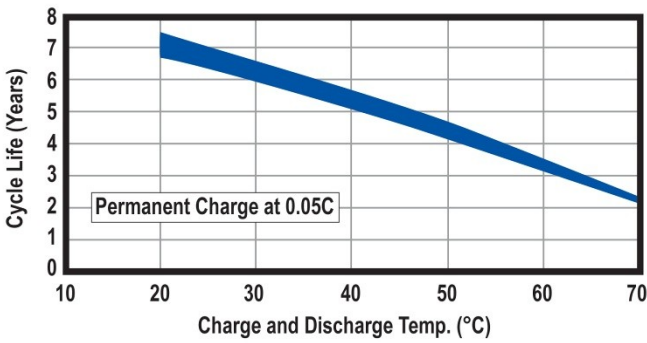

High Temp. Battery Charging and Discharging

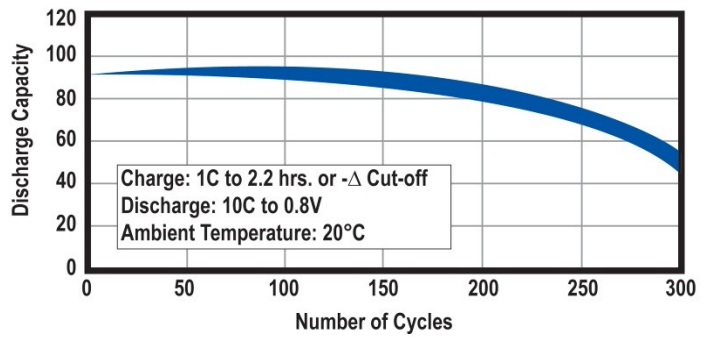

High Power (10C Discharge) Cycle Life

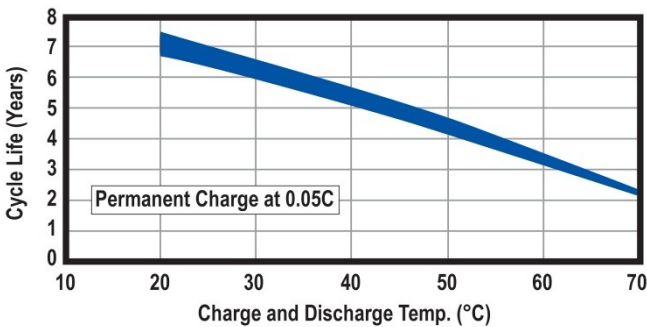

High Temp. Battery Discharge Cycle Life

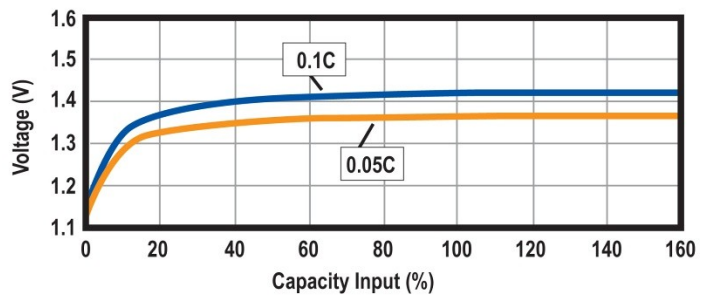

High Temp. Battery Trickle Charge

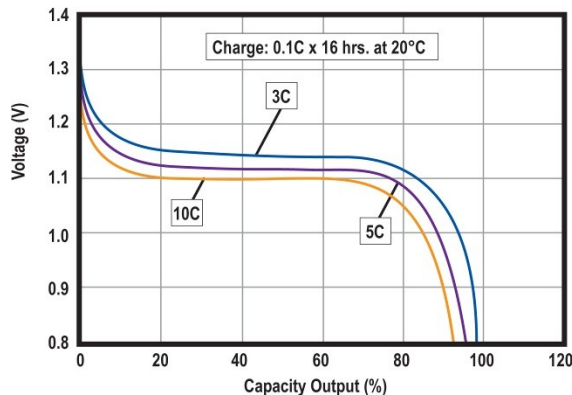

High Power Battery Discharging (3C/5C/10C)

Corporate Headquarters and Domestic Sales

Power-Sonic Corporation • 7550 Panasonic Way • San Diego, CA 92154 • U.S.A

Phone: (619) 661-2020 • Fax: (619) 661.3650

Email Sales: national-sales@power-sonic.com

Email Customer Service: customer-service@power-sonic.com

E-mail Technical Support: technical-support@power-sonic.com

International Sales

Power-Sonic Corporation • P.O. Box 5242 • Redwood City, CA 94063 • U.S.A.

Phone: (650) 364-5001 • Fax: (650) 366-3662

Email Sales: international-sales.com@power-sonic.com

www.power-sonic.com